

**OPERATING INSTRUCTIONS**

**CEQ™ 28R**

**COMPUTER CONTROLLED**

**GRAPHIC EQUALIZER**



**PEAVEY®**

ARCHITECTURAL  
ACOUSTICS®

## INTRODUCTION

### 1. DESCRIPTION

Thank you for purchasing the Peavey Architectural Acoustics CEQ™ 28R. If you are not yet familiar with the operation of the Peavey Architectural Acoustics CEQ™ 28, we recommend that you take a few minutes to read the CEQ 28 manual and familiarize yourself with its operation before proceeding with this manual.

The CEQ 28R is a 28 band, 1/3 octave graphic equalizer that is a companion to the CEQ 28. It can be used as a slave equalizer that tracks EQ changes made on the CEQ 28 or as an independent equalizer that is remotely controlled from the CEQ 28. When the CEQ 28R is used as a remote expander, the CEQ 28 front panel controls and display are used to control the CEQ 28R so that it operates just like the CEQ 28. By adding CEQ 28Rs, up to 16 channels of audio can be individually equalized from one CEQ 28.

Once curves are loaded or created in the CEQ 28R, the CEQ 28 can be removed so that the EQ curve you have carefully created cannot be altered. However, any of the

128 stored curves can be recalled via MIDI program change commands (if enabled), or the CEQ 28R can be set to a mode that allows one of 2, 4, or 8 presets to be recalled from the front panel.

### 2. FEATURES

- 28-Band graphic equalizer on 1/3 octave centers
- 26-Band constant Q filters
- Top and bottom bands (32 Hz and 16 kHz) are shelving filters
- MIDI controllable sliders, +/- 12 dB in 1 dB steps, or +/- 6 dB in 0.5 dB steps
- 128 Complete EQ curve memories
- Curves may be added
- Multi-function display
- Turn On/Off transient muting
- Compact 1 I.U. rack-mount configuration

## FRONT PANEL

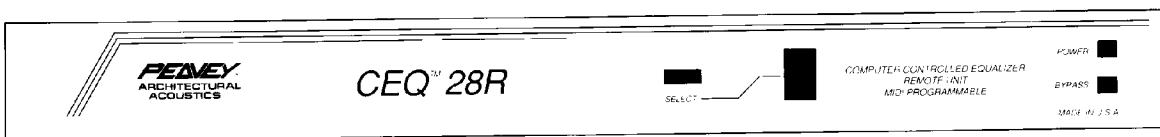

1. 7-segment display
2. Select button

The Select button and display can be set for 5 different display and control modes for selecting the MIDI channel or recalling EQ curves.

3. Power ON/OFF
4. Equalizer Bypass

## II. FRONT PANEL DISPLAY AND CONTROL OPTIONS

### 1. DISPLAY MODES

There are five different front panel display and control modes. (The CEQ 28R is shipped from the factory in Mode 1)

#### MODE 1:

The front panel 7 segment display indicates the CEQ 28R's MIDI listening channel. The decimal point lights to indicate when the CEQ 28R is in OMNI mode. The Select button is used to change the MIDI channel.

#### MODE 2:

The display functions the same as Mode 1, but the Select button is disabled.

#### MODES 3, 4, & 5:

In modes 3, 4, and 5, the MIDI channel is displayed and can be changed the first 3 seconds after the CEQ 28R is turned on. The select button can then be used to recall one of the available preset curves and the number of the curve is displayed.

#### MODE 3:

Preset curve 1 or 2 can be recalled.

#### MODE 4:

Preset curve 1, 2, 3, or 4 can be recalled.

#### MODE 5:

Preset curve 1, 2, 3,... 7, or 8 can be recalled.

## 2. CHANGING THE DISPLAY MODE

To change operating mode:

1. Turn off the power switch and disconnect the power cord.
2. Remove the 7 screws that secure the top.
3. Locate the header and jumper as shown in the diagram below.
4. Plug the jumper into the header in the position that corresponds with desired mode.
5. Replace the 7 screws that secure the top.

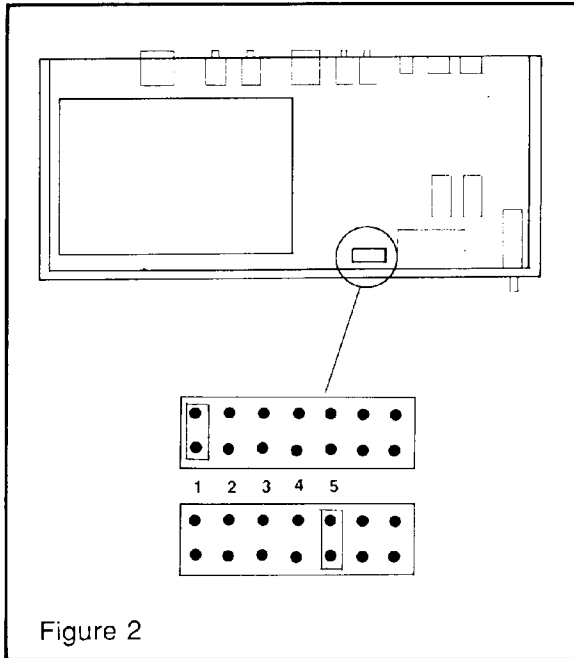

Figure 2

## 3. MIDI CHANNEL DISPLAY

MIDI channels 1 through 16 can be selected as described above and will appear on the display as:

CHANNEL DISPLAY	CHANNEL DISPLAY
1 - 1	9 - 9
2 - 2	10 - A
3 - 3	11 - b
4 - 4	12 - C
5 - 5	13 - d
6 - 6	14 - E
7 - 7	15 - F
8 - 8	16 - g

The decimal point, when lit, indicates that OMNI receive mode is on.

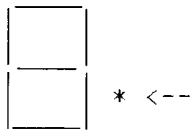

OMNI receive mode only applies to the receipt of MIDI program change and controller change commands. System exclusive messages are still only received on the selected channel.

## 4. TO SELECT A NEW MIDI CHANNEL

Press and hold the select button until the desired channel appears in the display. You must be either in mode 1 or press the button during the first 3 seconds after turning the power on if in modes 3, 4, or 5. There is a long delay before the display actually starts changing to prevent the channel from accidentally being changed, so be patient. The channel number increases in sequence "1" through "g" first with OMNI mode off, then again with OMNI mode on.

## 5. EQUALIZER BYPASS

The CEQ 28R equalizer can be bypassed by pressing the bypass switch located below the power switch on the front panel. When the equalizer is bypassed, the center bar of the display lights as shown below:

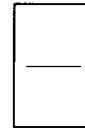

When the equalizer is bypassed, the subsonic filter remains in the circuit to protect the speaker system.

## 6. MIDI ACTIVITY

Whenever a valid MIDI message is received by the CEQ 28R, the display indicates MIDI activity by displaying 3 horizontal bars as shown below.

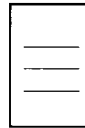

## III. CEQ 28 REMOTE CONTROL OF THE CEQ 28R

This manual assumes that you are familiar with the operation of the CEQ 28. If you are unfamiliar with the CEQ 28, take a few minutes to go through the CEQ 28 manual with the CEQ 28.

### 1. MIDI COMMUNICATION

When the CEQ 28 is in the "Remote" mode to control an CEQ 28R, MIDI system exclusive messages are used which must be on the receiving units channel. The communication in this mode is two-way. For each message that the CEQ 28R receives, it must send a return message that either contains the requested information (like current EQ curve data, label for a preset, etc.) or acknowledges the receipt of information.

### 2. MIDI CONNECTIONS BETWEEN THE CEQ 28 AND CEQ 28R

To establish the required two-way communication, the CEQ 28 and CEQ 28R(s) are wired in a loop. The MIDI output of the CEQ 28 goes to the MIDI input of the first CEQ 28R. The CEQ 28R is MIDI output then goes to the MIDI input of the next CEQ 28R, until the output of the final CEQ 28R is connected to the MIDI input of the CEQ 28.

**CEQ 28**

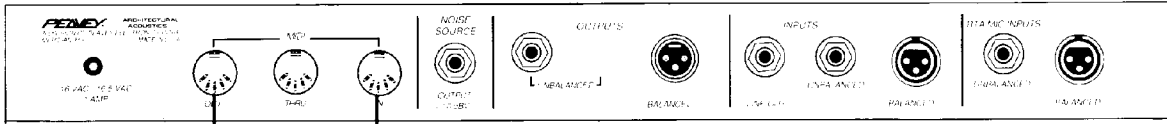

**CEQ 28R**

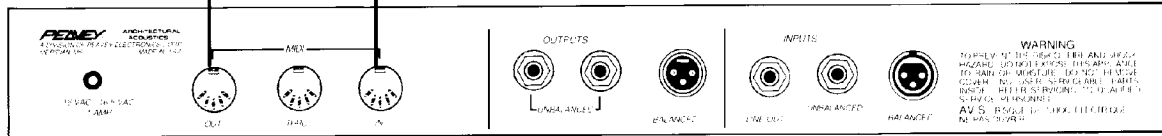

**CEQ 28**

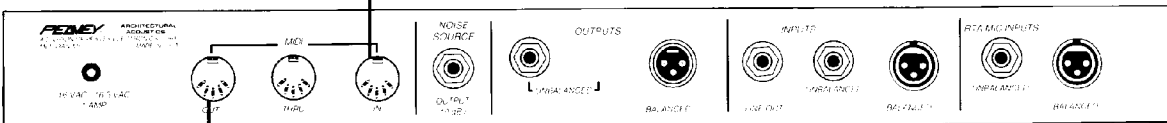

**CEQ 28R**

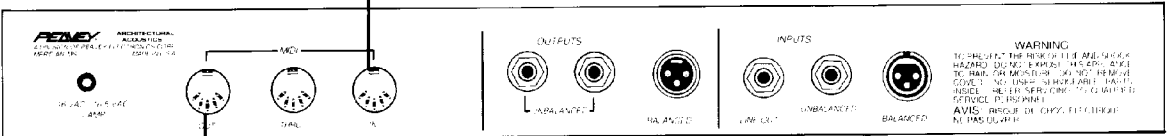

**CEQ 28R**

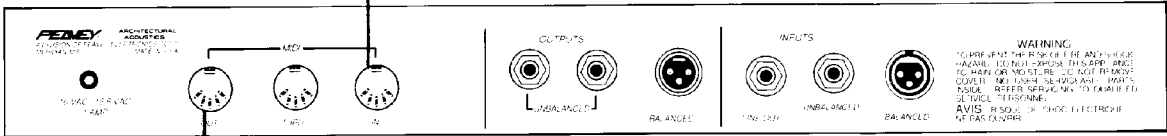

**CEQ 28R**

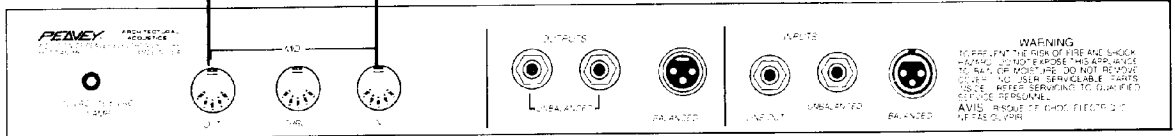

### 3. SETTING THE MIDI CHANNEL FOR REMOTE COMMUNICATION

The CEQ 28 and each CEQ 28R must be set to a different MIDI channel. If an CEQ 28R is set to the same channel as another CEQ 28R or the master CEQ 28, proper communication will not take place.

#### TECHNICAL EXPLANATION

When a CEQ 28R receives a system exclusive message that is not on its channel, it echoes the message to its MIDI output. System exclusive messages that the CEQ 28R receives on its listening channel are not echoed to its output. So, if more than one CEQ 28R were on the same channel, messages would never reach the second CEQ 28R. If an CEQ 28R were on the same channel as the CEQ 28 master, that CEQ 28R would intercept messages intended for the master and an error message would appear on the CEQ 28's display.

- The MIDI output of the CEQ 28 is connected to the MIDI input of the CEQ 28R.
- The MIDI output of the CEQ 28R is connected to the MIDI input of the CEQ 28.
- The remote channel that you selected in the CEQ 28 display is the same as the channel that the CEQ 28R is set to (MIDI channel 2).
- The CEQ 28 is set to a different MIDI channel than any of the CEQ 28Rs.
- The CEQ 28 is set to receive MIDI system exclusive messages.

This message will appear any time during remote operation of the two-way communication between the CEQ 28 and CEQ 28R is lost.

To return to control of the CEQ 28, position the cursor to the left of the "REMOTE" model label. Press either the up or down cursor key to get into Local Mode.

### A. ASSIGN PAGE FUNCTIONS

#### 1. SELECTING A CEQ 28R FOR REMOTE CONTROL

For this section, connect one CEQ 28R to the CEQ 28 and follow along with the instructions.

Set the CEQ 28 to MIDI channel 1 and the CEQ 28R to MIDI channel 2.

Press the Assign button on the CEQ 28R.

Use the left or right ( < or > ) cursor keys to move the blinking cursor to the left of Remote channel select.

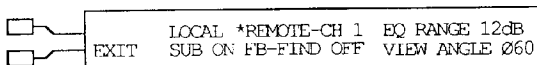

Use the Up or Down cursor keys ( ^ or v ) to select the channel of the CEQ 28R that you wish to control.

Now move the cursor to the left of the "LOCAL" mode label.

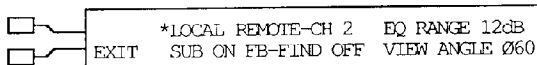

Press either the Up or Down cursor keys ( ^ or v ) to toggle the CEQ 28 into the Remote control mode. If the CEQ 28R responds with all of the appropriate data, the following display will momentarily appear on the CEQ 28.

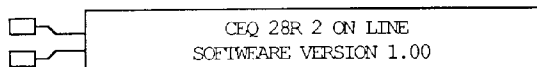

The assign page then reappears with the Local label replaced by Remote, and EQ range and Subsonic switches reflecting the way the CEQ 28R is set.

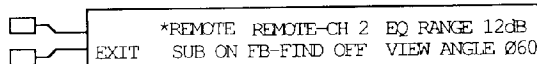

If, instead of the above message, the following message appeared,

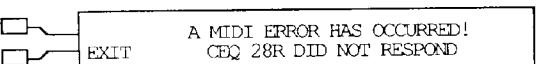

check to see that:

#### 2. EQ RANGE, SUBSONIC FILTER, AND FEEDBACK FIND

The 40 Hz subsonic filter and EQ range can now be changed in the remote CEQ 28R by positioning the blinking cursor to the left of the desired parameter, then using the UP or DOWN keys to change that parameter. This is the same way that these functions would be changed on the CEQ 28. However, because the feedback-find feature works with the line signal going through the CEQ 28, you cannot access this feature while in the REMOTE mode.

#### 3. EQ DISPLAY AND FUNCTIONS

Press the EQ function selector button.

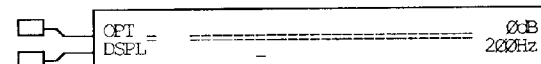

The EQ display now shows the curve of the remote CEQ 28R.

Pressing the DSPL soft key once will select the vertical 6 band EQ display mode.

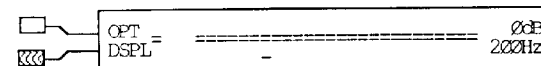

Pressing the DSPL soft key again will select the "Set Equalizer Flat" display.

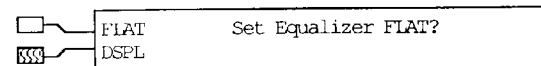

Pressing the DSPL soft key a third time will return you to the original EQ display. Because the CEQ 28R does not have an RTA, the EQ over RTA display is omitted.

Use the cursor keys to adjust the equalizer. As you see, the buttons and display behave the same as when you are in the "Local" mode controlling the CEQ 28. You may notice, however, that the rate the cursor scrolls as you hold the button down to raise or lower the level of a band may vary slightly as the number of CEQ 28Rs in the loop is increased.

Pressing the "OPT" key brings up the ADD EQ curve display which works the same as the corresponding CEQ 28 display. Pressing the UP or DOWN keys with the cursor to the left of ADD toggles the ADD mode on and off. When the cursor is at the added program number, pressing

the up or down keys changes the program preset that is added to the current EQ curve. The change actually takes place when you release the button.

Pressing the EXIT soft key returns you to EQ display.

If you press the NEXT soft key, the "compare two curves" display appears. This also functions the same as the CEQ 28.

#### 4. STORE

The store display and functions are the same as those in the CEQ 28.

To store a curve, press the STORE button.

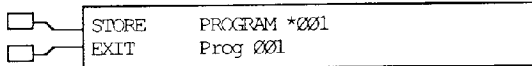

Now, using the UP  $\blacktriangle$  or  $\blacktriangledown$  DOWN keys to select a new character. The LEFT or RIGHT arrow keys are used to select which of the 8 character positions you wish to change.

To change the user label, press the RIGHT  $\blacktriangleright$  arrow key and the display will look like this:

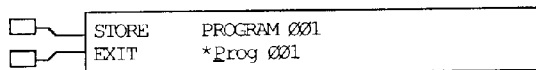

The underline cursor indicates the character of the label to be modified. Use the UP  $\blacktriangle$  or  $\blacktriangledown$  DOWN keys to select a new character. The LEFT or RIGHT arrow keys are used to select which of the 8 character positions you wish to change.

To store a curve, press the STORE soft key (The top soft key). The display will momentarily show:



Your curve and label are now stored. If you have the CEQ 28R front panel set to modes 3, 4, or 5, where the user can recall preset curves, be sure to store the curve in a location that can be accessed.

#### 5. RECALL

The RECALL display and functions are the same as those in the CEQ 28.

To recall a stored EQ curve, press the RECALL button and the recall display will appear.

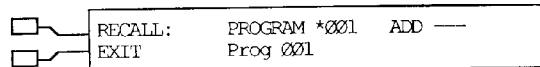

Use the UP  $\blacktriangle$  or  $\blacktriangledown$  DOWN arrow keys to select the program preset curve to recall. The user label at the bottom of the display will not be updated to reflect the newly selected preset until the button is released.

Pressing the RIGHT arrow  $\blacktriangleright$  key will move the cursor to the left of the ADD label and allow the selected preset curve to be recalled with or without an ADD curve.

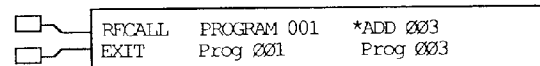

If the ADD function is on, the cursor may be moved to the right to select the program preset number to be added. For more information on adding curves, refer to the CEQ 28 manual.

To recall the selected curve, press the recall soft key (top soft key). The following display will momentarily appear.

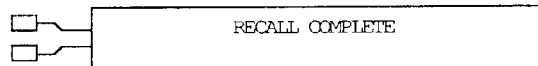

Recall Complete.

### B. MIDI PAGE FUNCTIONS

#### 1. MIDI MAIN MENU

Press the MIDI selector button and the following display will appear.

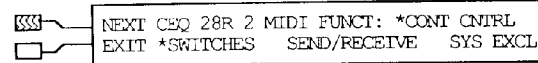

Use the left or right ( $\blacktriangleleft$  or  $\blacktriangleright$ ) cursor keys to select the desired function. Then press the "NEXT" soft key to go to that display.

#### 2. SETTING MIDI CONTINUOUS CONTROLLERS

Select the set continuous controllers function (Place the cursor to the left of "CONT CNTRL"). Now press the "NEXT" soft key. The following display will appear.

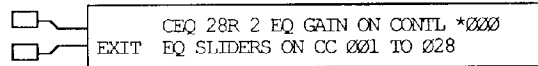

Individual EQ "sliders" can be controlled via MIDI continuous controller messages. The controller numbers are assigned in this page. The 29 sliders are configured as a contiguous block, starting with EQ gain, then the 32 Hz band, followed by 40 Hz, on up to the 16 kHz band. The starting controller number can be changed by using the up or down ( $\blacktriangle$  or  $\blacktriangledown$ ) cursor keys to a value ranging from 0 to 92.

NOTE: You may notice, as you change the controller number, that the display will skip some blocks of numbers. This happens because the CEQ 28 checks for conflict between the Gain and EQ Slider block and the Subsonic and EQ Range MIDI controller switches, and skips numbers that would cause more than one control to be assigned to one number.

#### 3. MIDI Subsonic and EQ Range switches

The Subsonic filter and EQ Range can be changed by using MIDI controller change commands. The controller number assigned to each of these switches is selected in the MIDI Switches display.

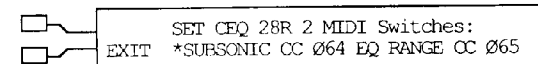

Pressing the LEFT  $\blacktriangleleft$  or  $\blacktriangleright$  RIGHT cursor keys selects either the subsonic or EQ range controller and the UP  $\blacktriangle$  or  $\blacktriangledown$  DOWN keys change the controller number.

#### 4. MIDI SEND AND RECEIVE ENABLE

The receipt of MIDI program change and controller change commands can be enabled or disabled in this display.

In the MIDI main menu, move the blinking cursor to the left of the SEND/RECEIVE label.

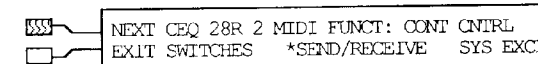

Press the NEXT soft key to go to the send/receive display.

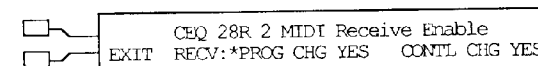

Use the LEFT < or > RIGHT arrow keys to select the parameter to change and the UP ▲ or ▼ DOWN keys to toggle the receive enable between YES and NO.

### 5. MIDI SYSTEM EXCLUSIVE (DUMP PRESET)

To dump one or all presets from the CEQ 28R to the CEQ 28, connect only one CEQ 28R to the CEQ 28 as shown below.

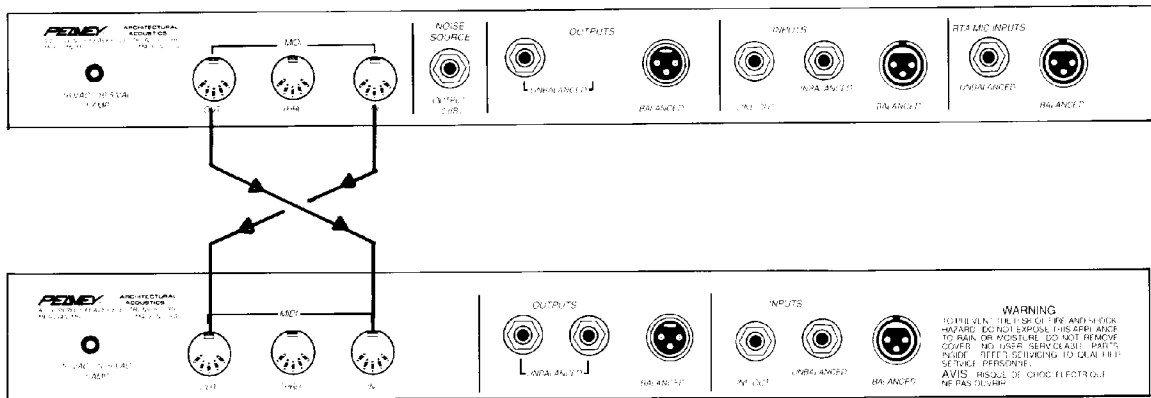

Set both units to the SAME MIDI channel.  
On the CEQ 28, select Remote mode to control the CEQ 28R.

**NOTE:** Dumping preset curves from the CEQ 28R to the CEQ 28 will destroy the existing CEQ 28 curve stored in that preset location. For example: If you dump preset #1 from the CEQ 28R to the CEQ 28, the CEQ 28's preset #1 will be replaced with preset #1 dumped from the CEQ 28R.

Press the MIDI button. Now use the left or right cursor keys to move the blinking cursor to the left of the SYS EXCL label.

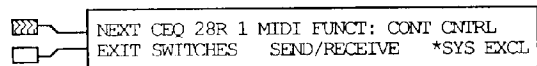

Press the NEXT soft key and the following display will appear.

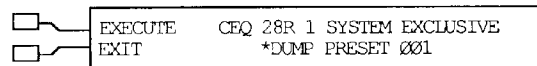

Use the up or down cursor keys to select the preset to be dumped or select ALL to dump all 128 presets. (ALL is below 001 or above 128)

Press the EXECUTE soft key to send the Dump request to the CEQ 28R.

The CEQ 28 will display:

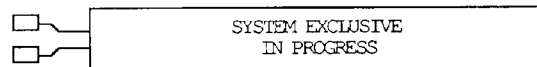

The CEQ 28R will show the three bar MIDI activity display.



To dump presets to another device, you can either send a MIDI dump request from that device as described in the MIDI System Exclusive specification; or you can proceed as instructed above, but, just before pressing the EXECUTE soft key, connect the receiving device to the MIDI output of the CEQ 28R. The CEQ 28 will show the following message on the display.

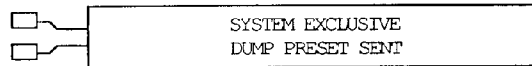

When performing a system exclusive dump from the CEQ 28R, its MIDI output need not be connected to the CEQ 28 MIDI input.

### 6. CEQ 28R MIDI COMMAND SUMMARY

The CEQ 28R responds to MIDI program change commands by recalling the Preset EQ curve requested. The CEQ 28R must be listening on the correct MIDI channel or be in OMNI mode. When the CEQ 28R receives a valid program change command, it will display 3 bars in its front panel display.

The CEQ 28R will receive MIDI controller commands that are on the correct MIDI channel and for controller numbers assigned to EQ sliders or switches. The CEQ 28R responds by displaying the 3 bar MIDI activity indicator and by changing the appropriate EQ slider or switch. When in OMNI mode, the CEQ 28R will receive MIDI controller changes messages sent on any channel.

The system exclusive messages that the CEQ 28R sends and receives are outlined in the MIDI implementation section.

### 7. FACTORY RESET OF MEMORY

If you have changed many of the MIDI communication parameters or if you wish to erase all of the EQ curve stored in memory, you can reset the CEQ 28's memory to the factory settings.

**CAUTION:** When the following action is performed, all of the stored curves, EQ settings, and other setup changes are returned to the factory settings. **ALL STORED CURVES ARE LOST!** If you wish to save any of the stored curves, use a MIDI System Exclusive dump to the CEQ 28.

Connect the CEQ 28R and CEQ 28 together via MIDI. Turn the CEQ 28R power on and the CEQ 28 power off. Press and hold the RECALL and STORE keys on the CEQ 28 while turning the CEQ 28's power on. The following display will appear.

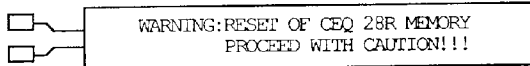

Now simultaneously press the left and right cursor keys. The display will change to:

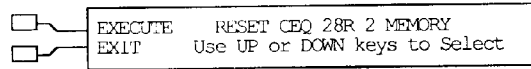

Use the up or down cursor keys to select the number of the CEQ 28 to reset.

Press the EXECUTE soft key (top soft key) to perform the memory reset. Pressing the EXIT soft key aborts reset.

### 8. RTA EQUALIZATION USING THE CEQ 28 AND CEQ 28R

The RTA built into the CEQ 28 can be used to remotely equalize a sound system with the CEQ 28R. The RTA and auto-equalization functions look identical to those for the CEQ 28 alone, but the CEQ 28R is actually adjusted instead of the CEQ 28. First, connect the CEQ 28 and CEQ 28R as shown below.

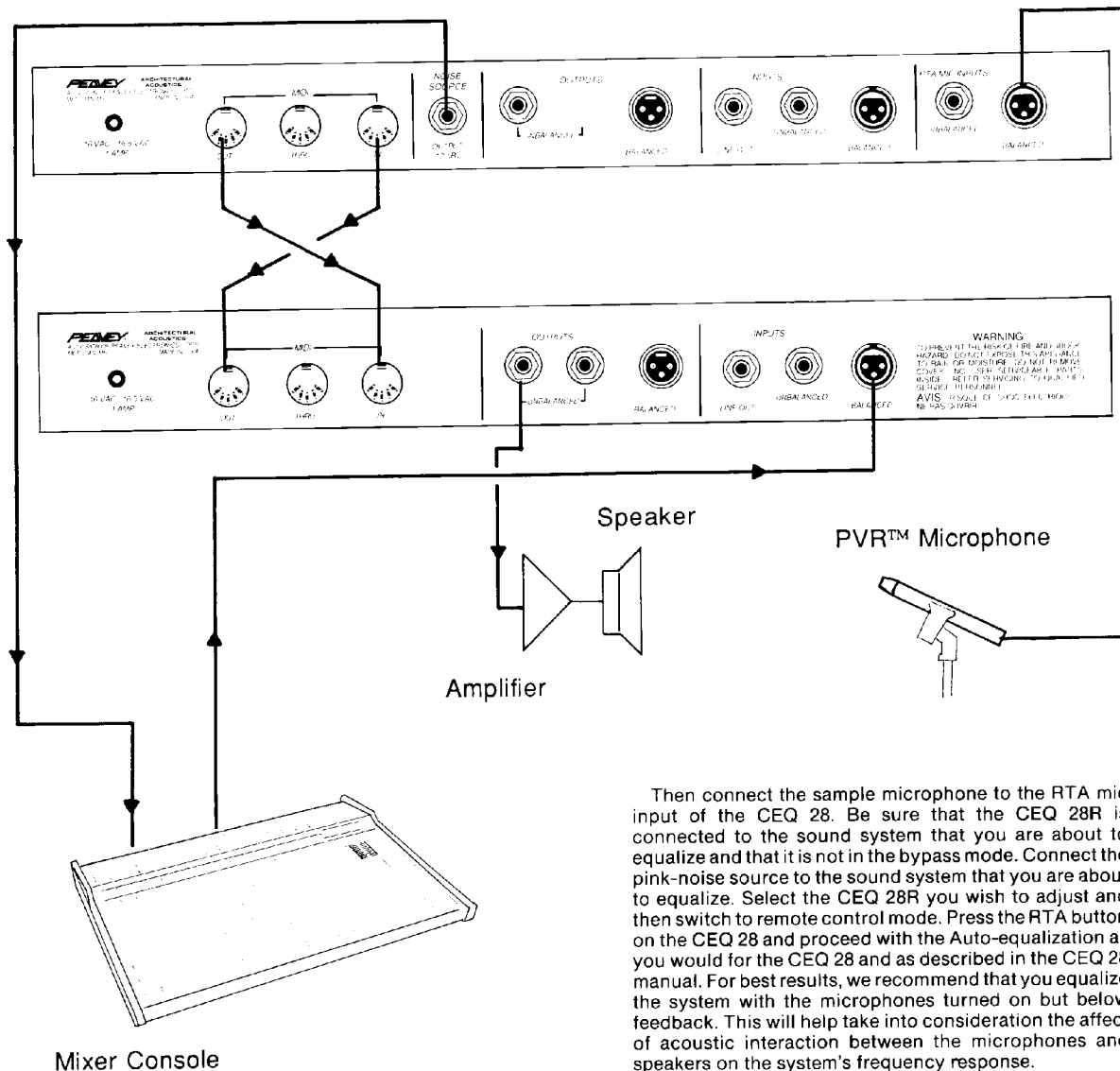

Then connect the sample microphone to the RTA mic input of the CEQ 28. Be sure that the CEQ 28R is connected to the sound system that you are about to equalize and that it is not in the bypass mode. Connect the pink-noise source to the sound system that you are about to equalize. Select the CEQ 28R you wish to adjust and then switch to remote control mode. Press the RTA button on the CEQ 28 and proceed with the Auto-equalization as you would for the CEQ 28 and as described in the CEQ 28 manual. For best results, we recommend that you equalize the system with the microphones turned on but below feedback. This will help take into consideration the affect of acoustic interaction between the microphones and speakers on the system's frequency response.



After completing the equalization of the system with the CEQ 28R, press the EQ button to examine the resulting curve. If some bands are set to large amounts of boost, you may wish to cut them manually before proceeding to store the curve. You should pay particular attention to the lowest and highest frequency bands. If all looks well, then store the curve in one of the 128 presets. If you plan on using the front panel recall feature on the CEQ 28R, be sure to store the curve in one of the locations that the front panel can access. For the recall of two preset curves mode, it must be stored in locations 1 or 2. For the recall of 4 preset curves mode, it must be in 1, 2, 3, or 4. For recall of 8, it must be stored in 1 to 8.

#### IV. THE CEQ 28 TRACKS THE CEQ 28R

##### 1. DESCRIPTION

In this mode of operation, the CEQ 28R will always have the same EQ curve as the CEQ 28 it's connected to. As the

EQ curve is manually adjusted, the same changes will be made in the CEQ 28R. This mode can be useful for stereo operation when you want to equalize both channels the same to maintain proper stereo imaging.

##### 2. CONNECTIONS AND SETUP

Connect the MIDI output of the CEQ 28 to the MIDI input of the CEQ 28R.

Set both the CEQ 28 and CEQ 28R to the same MIDI channel, or set the CEQ 28R to the OMNI receive mode.

Set the CEQ 28 to send MIDI program change and controller change messages. The CEQ 28R must also be set to receive these messages.

Be sure that both the CEQ 28 and CEQ 28R have the EQ sliders and MIDI switches set to the same MIDI controller numbers.

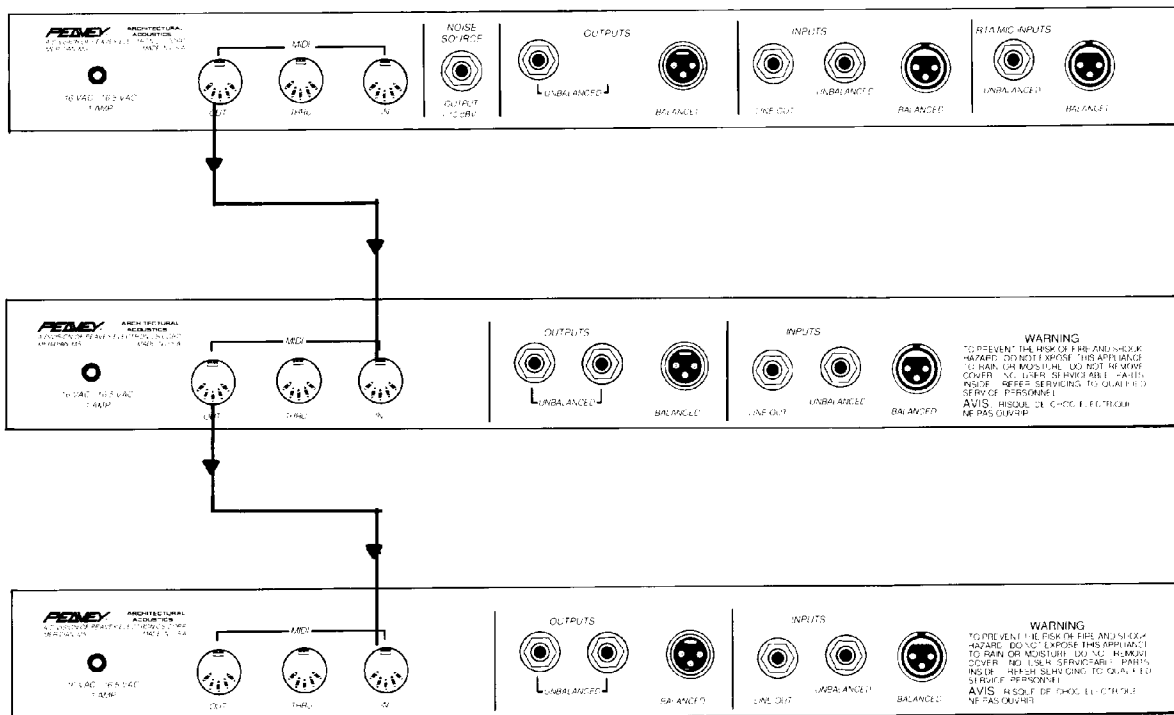

**NOTE:** The CEQ 28 and CEQ 28R are set up, ready for communication from the factory.

Now, as you manually adjust an EQ slider on the CEQ 28, the same change is being made on the CEQ 28R. You can confirm that the CEQ 28R is getting the messages if the CEQ 28R display changes to 3 bars when an EQ change is made.

What we have not yet considered is that the two equalizers may contain different EQ curves when we start. Each time an EQ band is adjusted on the CEQ 28, the corresponding band on the CEQ 28R will be set the same. However, if you don't adjust all bands of the equalizer, then the unadjusted bands may be set differently. It is best to either set both equalizers flat or recall identical curves before starting manual adjustment.

We also must consider what happens when a curve is recalled on the CEQ 28. Performing a recall on the CEQ 28

causes the corresponding preset on the CEQ 28R to be recalled. But if the CEQ 28 and CEQ 28R have different curves stored in their preset memories, the two EQ curves will be different. The best way to solve these problems is to dump the desired preset curves (or ALL presets) via a system exclusive dump from the CEQ 28 to the CEQ 28R. Then recall one of those curves to assure that both units have the same EQ settings. If you create a new curve and store it in the CEQ 28, be sure to remember to also dump the preset containing the new curve to the CEQ 28R.

If you want additional CEQ 28Rs to track the master CEQ 28, connect each in turn to the MIDI output of the previous CEQ 28R. Taking the signal from the CEQ 28R's MIDI output instead of its thru keeps the MIDI signal from deteriorating as multiple units are added.

## CEQ™ 28R SPECIFICATIONS

All specifications are typical unless otherwise noted.  
0 dBV = 1 Volt

All specifications are referenced to nominal output level (0 dBV) unless otherwise noted.

All measurements are wideband 20 Hz to 20 kHz unless otherwise stated.

NOTE: All specs measured at 1V RMS input and unbalanced output. All sliders at mid position, all switches out unless otherwise noted.

**Frequency Response: (Balanced and Unbalanced Outputs)**

+/- 1 dB 20 Hz - 20 kHz

**Distortion:**

Less than .01% (20 - 20K) .005% Typical

**Common Mode Rejection Ratio (CMRR):**

36 dB Typical

**Input Impedance:**

Unbalanced: 20K ohms  
Balanced: 20K ohms (equal impedances to ground)

**Output Impedance:**

Unbalanced: 1K ohms  
Balanced: 2K ohms

**Maximum Input Level:**

Unbalanced: +23 dBV (14V RMS)  
Balanced: +23 dBV (14V RMS)

**Maximum Output Level:**

Unbalanced: +17 dBV (7V RMS)  
Balanced: +23 dBV (14V RMS)

**Nominal Input Level:**

Unbalanced: 0 dBV (1V RMS)  
Balanced: 0 dBV (1V RMS)

**Nominal Output Level:**

Unbalanced: 0 dBV (1V RMS)  
Balanced: +6 dBV (2V RMS)

**Input Headroom:**

Nominal = 23 dB

**Output Headroom:**

Unbalanced: 17 dB  
Balanced: 17 dB

**Output Noise: Unbalanced Output**

EQ Out: -95 dBV  
EQ In, all Flat: -90 dBV

**Filter Bandwidth:**

1/3 Octave

**Filter Frequencies:**

31.6, 40, 50, 63, 80, 100, 125, 160, 200, 250, 316, 400, 500, 630, 800, 1K, 1.25K, 1.6K, 2K, 2.5K, 3.16K, 4K, 5K, 6.3K, 8K, 10K, 12.5K, 16K

**Filter Q:**

4.77  
40 Hz to 12.5 kHz

**Shelving Filters:**

32 Hz and 16 kHz are 12 dB octave

**Maximum Boost & Cut Filters:**

+/- 12 dB (+/- 12 dB Position)  
+/- 6 dB (+/- 6 dB Position)

**Maximum Boost & Cut Gain: (WideBand Gain)**

+/- 12 dB (+/- 12 dB Position)  
+/- 12 dB (+/- 6 dB Position)

**Subsonic Low Cut Filter:**

18 dB per octave

**Frequency:**

40 Hz

Date: Sept. 1989  
Version: 1.01

MODEL MIDI Implementation

Function. . .	Transmitted	Recognized	Remarks
Basic Channel Default Channel	1 1-16	1 1-16	
Mode Default Messages Altered		1,3	memorized Omni on/off
Note Number True Voice			
Velocity Note ON Note OFF	X X	X X	
After Touch Key's Ch's	X X	X X	
Pitch Bender	X	X	
Control Change	O	0-120 0 Volume 1 Band 1 (32Hz) " " 28 Band 28 (16kHz) 64 Subsonic Filter on/off 65 EQ Range 6/12dB	Programmable EQ Vol., Bands 1-28 Programmable as a block Subsonic, EQ Range Individually Programmable  Controller value 0 to 63; off 64 to 127; on 0 to 63; 6dB 64 to 127; 12dB
Prog Change True #	O	0-127	
System Exclusive	O	O	
System : Song Pos Common : Song Sel : Tune	X X X	X X X	
System : Clock Real Time : Commands	X X	X X	
Aux Messages : Local ON/OFF : All Notes Off : Active Sense : Reset	X X X X	X X X X	
Notes			

Mode 1: OMNI ON, POLY  
Mode 3: OMNI OFF, POLY

Mode 2: OMNI ON, MONO  
Mode 4: OMNI OFF, MONO

O: Yes  
X: No

### LIMITED WARRANTY

Peavey Electronics Corporation warrants to the original purchaser of this new Architectural Acoustics™ product that it is free from defects in material and workmanship. If within one (1) year from date of purchase a properly installed product proves to be defective and Peavey is notified, Peavey will repair or replace it at no charge. (Note: Batteries and patch cords not covered.) "Original purchaser" means the customer for whom the product is originally installed.

Damage resulting from improper installation, interconnection of a unit or system of another manufacturer, accident or unreasonable use, neglect or any other cause not arising from defects in material and workmanship is not covered by this warranty. The warranty is valid only as to products purchased and installed in the United States.

**THIS LIMITED WARRANTY IS IN LIEU OF ANY AND ALL WARRANTIES, EXPRESS OR IMPLIED, INCLUDING THE IMPLIED WARRANTIES OF MERCHANTABILITY AND FITNESS FOR A PARTICULAR USE. UNDER NO CIRCUMSTANCES WILL PEAVEY BE LIABLE FOR ANY LOST PROFITS, LOST SAVINGS, INCIDENTAL DAMAGES OR CONSEQUENTIAL DAMAGES ARISING OUT OF THE USE OR INABILITY TO USE THE PRODUCT, EVEN IF PEAVEY HAS BEEN ADVISED OF THE POSSIBILITY OF SUCH DAMAGE. THIS LIMITED WARRANTY IS THE ONLY EXPRESS WARRANTY ON THIS PRODUCT, AND NO OTHER STATEMENT, REPRESENTATION, WARRANTY OR AGREEMENT BY ANY PERSON SHALL BE VALID OR BINDING UPON PEAVEY.**

Peavey's liability to the original purchaser for damages for any cause whatsoever and regardless of the form of action, is limited to the actual damages up to the greater of Five Hundred Dollars (\$500) or an amount equal to the purchase price of the product that caused the damage or that is the subject of or is directly related to the cause of action. This limitation of liability will not apply to claims for personal injury or damage to real property or tangible personal property allegedly caused by Peavey's negligence. For information on service under this warranty, call a Peavey customer service representative at (601) 483-5376.

**DANGER**

EXPOSURE TO EXTREMELY HIGH NOISE LEVELS MAY CAUSE A PERMANENT HEARING LOSS. INDIVIDUALS VARY CONSIDERABLY IN SUSCEPTIBILITY TO NOISE INDUCED HEARING LOSS, BUT NEARLY EVERYONE WILL LOSE SOME HEARING IF EXPOSED TO SUFFICIENTLY INTENSE NOISE FOR A SUFFICIENT TIME.

THE U.S. GOVERNMENT'S OCCUPATIONAL SAFETY AND HEALTH ADMINISTRATION (OSHA) HAS SPECIFIED THE FOLLOWING PERMISSIBLE NOISE LEVEL EXPOSURES:

DURATION PER DAY IN HOURS	SOUND LEVEL dBA, SLOW RESPONSE
8	90
6	92
4	95
3	97
2	100
1	102
1/2	105
1/4	110
1/8	115

\* or less

ACCORDING TO OSHA, ANY EXPOSURE IN EXCESS OF THE ABOVE PERMISSIBLE LIMITS COULD RESULT IN SOME HEARING LOSS. EAR PLUGS OR PROTECTORS IN THE EAR CANALS OR OVER THE EARS MUST BE WORN WHEN OPERATING THIS AMPLIFICATION SYSTEM IN ORDER TO PREVENT A PERMANENT HEARING LOSS IF EXPOSURE IS IN EXCESS OF THE LIMITS AS SET FORTH ABOVE TO INSURE AGAINST POTENTIALLY DANGEROUS EXPOSURE TO HIGH SOUND PRESSURE LEVELS. IT IS RECOMMENDED THAT ALL PERSONS EXPOSED TO EQUIPMENT CAPABLE OF PRODUCING HIGH SOUND PRESSURE LEVELS, SUCH AS THIS AMPLIFICATION SYSTEM, BE PROTECTED BY HEARING PROTECTORS WHILE THIS UNIT IS IN OPERATION.

**CAUTION**

THIS MIXING CONSOLE EFFECTS DEVICE/PREAMP HAS BEEN DESIGNED AND CONSTRUCTED TO PROVIDE ADEQUATE SIGNAL VOLTAGE FOR PLAYING MODERN MUSIC. IMPROPER USE OF THE GAIN/EQUALIZER CONTROLS AND/OR IMPROPER USE OF INTERNAL/EXTERNAL BUSES MAY CREATE CLIPPING (SQUARE WAVES) AND POSSIBLY CAUSE SUBSEQUENT DAMAGE TO THE LOUDSPEAKER SYSTEMS. EXTENDED OPERATION OF THE GAIN/EQUALIZATION CONTROLS IN THEIR MAXIMUM POSITIONS IS THEREFORE NOT RECOMMENDED. PLEASE BE AWARE THAT MAXIMUM POWER CAN BE OBTAINED WITH VERY LOW SETTINGS OF THE GAIN/EQUALIZATION CONTROLS IF THE INPUT SIGNAL IS VERY STRONG.

IT IS COMMON PRACTICE AMONG USERS OF SOUND REINFORCEMENT EQUIPMENT TO IDENTIFY THE INDIVIDUAL CHANNELS WITH A STRIP OF TAPE PLACED ABOVE OR BELOW THE ROW OF VOLUME FADERS. MANY TYPES OR BRANDS OF TAPE HAVE A VERY STRONG ADHESIVE WHICH CAN INHIBIT THE PAINT ON THE FACEPLATE AND ACTUALLY REMOVE THE PAINT WHEN THE TAPE IS REMOVED. WE STRONGLY RECOMMEND THAT SCOTCH TAPE NOT BE USED ON PAINTED SURFACES NOR ANY OTHER TAPE THAT IS NOT SPECIALLY DESIGNED FOR SUCH APPLICATIONS. MARKING WILL LIGHT ADHESIVE MARKING OR TAPE LABEL TAPE IS RECOMMENDED IF TAPE IS USED. ANY TAPE LEFT ON PAINTED SURFACE FOR EXTENDED PERIODS WILL BE DIFFICULT TO REMOVE. NEVER USE CLEAR OR SCOTCH TAPE FOR THESE APPLICATIONS.

1. Read all safety and operating instructions before using this product.
2. All safety and operating instructions should be retained for future reference.
3. Obey all cautions in the operating instructions and on the back of the unit.
4. All operating instructions should be followed.
5. This product should not be used near water (i.e. a bathtub, sink, swimming pool, wet basement, etc).
6. This product should be located so that its position does not interfere with its proper ventilation. It should not be placed flat against a wall or placed in a built-in enclosure that will impede the flow of cooling air.
7. This product should not be placed near a source of heat such as a stove, radiator or another heat producing amplifier.
8. Connect only to a power supply of the type marked on the unit adjacent to the power supply cord.
9. Never break off the ground pin on the power supply cord. For more information on grounding, write for our free booklet "Shock Hazard and Grounding".
10. Power supply cords should always be handled carefully. Never walk or place equipment or power supply cords. Periodically check cords for cuts or signs of stress, especially at the plug and the point where the cord exits the unit.
11. The power supply cord should be unplugged when the unit is to be unused for long periods of time.
12. If this product is to be mounted in an equipment rack, rear support should be provided.
13. Metal parts can be cleaned with a damp rag. The vinyl covering used on some units can be cleaned with a damp rag, or an ammonia based household cleaner if necessary.
14. Care should be taken so that objects do not fall and liquids are not spilled into the unit through the ventilation holes or any other openings.
15. This unit should be checked by a qualified service technician if:
  - A. The power supply cord or plug has been damaged.
  - B. Anything has fallen on or been spilled into the unit.
  - C. The unit does not operate correctly.
  - D. The unit has been dropped or the enclosure damaged.
16. The user should not attempt to service this equipment. All service work should be done by a qualified service technician.



Features and specifications are subject to change

A DIVISION OF PEAVEY ELECTRONICS CORPORATION 711 A Street, P.O. Box 2898, Meridian, MS 39302-2898

#60301184

©1989 Printed in U.S.A.